

Replacement Part Numbers

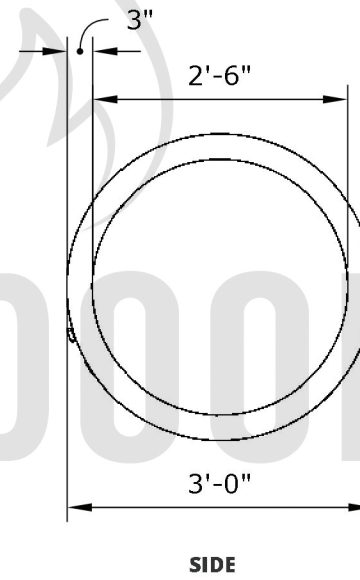
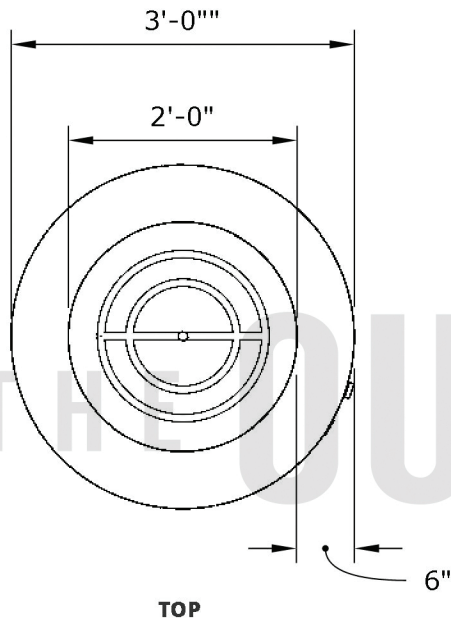

Beverly - 36" Fire Pit

Page Number	1 of 1
Author: Bryant Uribe	4/13/2018
Approved By: Gabriel Estrada	4/13/2018

Part Number	OPT-36RRCS, OPT-36RRSS
Material	Steel / Stainless Steel
Finishes	Corten Steel, Stainless Steel
Gas Type	Natural Gas (-NG) or Liquid Propane (-LP)
Weight	180 lbs.
BTUs	75,000
Suggested Fire Glass	50 lbs.
Access Door	Yes

ITEM NO.	REPLACEMENT PART NUMBER	QTY.
1	OPT-160	1
2	OPT-256	1
3	OPT-LATCH	1

Proprietary & Confidential: The information contained in this drawing is the sole property of **The Outdoor Plus**. Any reproduction or as a whole without written permission of **The Outdoor Plus** is prohibited.